

# NRGC-PN

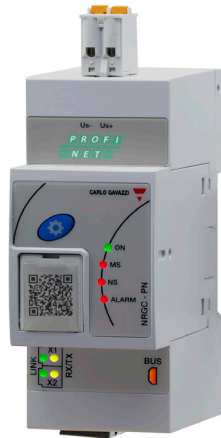

## NRG controller with PROFINET Communication



### Main features

- **Communication interface.** The NRG controller bridges the field level devices to the control level to allow exchange of data in real-time with the NRG solid state relays.
- **Reduced maintenance costs and downtime.** Use of real-time data for prevention of machine stoppages during operation.
- **Good quality products and low scrap rates.** Real-time monitoring allows timely decisions for better machine and process management.
- **Reduced efforts in troubleshooting.** A number of faults can be distinguished to facilitate and reduce troubleshooting time.
- **Fast installation and set-up.** Control, monitoring and diagnostics all possible via the communication system.
- **Compact dimensions.** One controller with a product width of 35 mm can handle up to 32 RG..CM..N solid state relays.

### Description

The **NRGC-PN** is the NRG controller in the NRG BUS chain.

The **NRGC-PN** interfaces directly with the main controller of the system through PROFINET communication. Each **NRGC-PN** in the system is identified by a unique MAC address which is printed on the façade of the product.

The **NRGC-PN** is mainly a facilitator of the communication between the main controller and each individual RG..N solid state relay in the system. The **NRGC-PN** also performs internal operations to setup and maintain the internal bus.

The **NRGC-PN** needs to be supplied with 24 VDC. LEDs on the front facade give a visual indication of the status of the **NRGC-PN**, of any ongoing communication with the main controller and the RG..Ns on the BUS chain and of any alarm condition related specifically to the **NRGC-PN**.

Specifications are noted at 25°C unless otherwise specified.

### Applications

Any heating application where reliable and precise maintenance of temperatures is crucial to the quality of the end product. Typical applications include plastic machinery such as injection machines, extrusion machines and PET blow moulding machines, packaging machinery, sterilisation machinery, drying tunnels and semiconductor manufacturing equipment.

### Main function

- Communication interface: PROFINET
- Connects up to 32 **RG..CM..Ns**
- Supply voltage 24 VDC +/-20%

## The NRG system

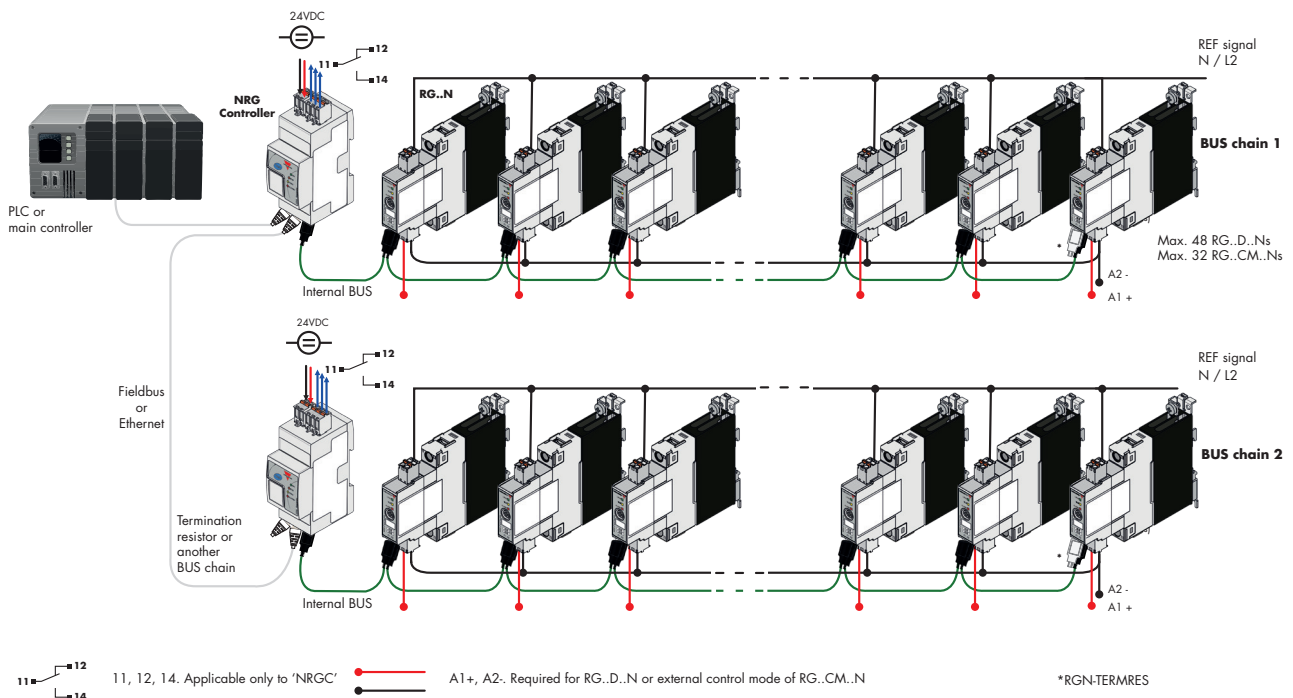

## System Overview

The NRG is a system consisting of one or more BUS chains that enable communication between the field devices (such as the solid state relays) and the control devices (such as the machine controller or PLC).

Each **NRG BUS** chain consists of the following 3 components:

- the NRG controller
- the NRG solid state relay(s)
- the NRG internal BUS cables

The **NRG controller** is the interface to the machine controller. It acts as the master of the BUS chain when performing specific actions on the respective BUS chain, and acts as a gateway for the communication between the PLC and the RG..N solid state relays. It is not possible to operate the NRG system without the NRG controller.

The NRG controllers available are:

- **NRGC**  
The NRGC is a NRG controller with a Modbus RTU interface over RS485. The NRGC is addressed via the assigned Modbus ID (from 1-247). In a NRG system operating on Modbus it is possible to have 247 NRG BUS chains.
- **NRGC-PN**  
NRGC-PN is a NRG controller with a PROFINET communication interface. The NRGC-PN is identified by a unique MAC address which is printed on the facade of the product. The GSD file can be downloaded from [www.gavazziautomation.com](http://www.gavazziautomation.com)
- **NRGC-EIP**  
NRGC-EIP is a NRG controller with an EtherNet/IP communication interface. The IP address is provided automatically via a DHCP server. The EDS file can be downloaded from [www.gavazziautomation.com](http://www.gavazziautomation.com)
- **NRGC-ECAT**  
NRGC-ECAT is a NRG controller with an EtherCAT communication interface. The ESI file can be downloaded from [www.gavazziautomation.com](http://www.gavazziautomation.com)
- **NRGC-MBTCP**  
NRGC-MBTCP is a NRG controller with a Modbus TCP communication interface.

## System Overview - continued

The **NRG solid state relay** is the switching component in the NRG system. Each **RG..N** integrates a communication interface to exchange data with the machine controller (or PLC). The available RG..Ns that can be used in an NRG system are:

- **RG..D..N**  
The RG..D..N are solid state relays for use in an NRG system having the communication interface only for real time monitoring. Control of the RG..N is done via a DC control voltage. It is possible to have maximum 48 **RG..D..Ns** in one NRG BUS chain.
- **RG..CM..N**  
The RG..CM..N are solid state relays for use in an NRG system having a communication interface for control of the RG..N through the BUS and for real time monitoring. It is possible to have a maximum of 32 RG..CM..N in one NRG bus chain. There are two variants of the RG..CM..N:  
**RGx1A..CM..N** - the solid state relay with zero cross switching  
**RGx1P..CM..N** - the solid state relay with proportional switching.

For a review of the features available in both variants refer to the table below:

Feature	RGx1A..CM..N	RGx1P..CM..N
External control	●	-
ON / OFF switching	●	●
Burst switching	●	●
Distributed full cycle switching	●	●
Advanced full cycle switching	●	●
Phase angle	-	●
Soft start with time mode	-	●
Soft start with current limit mode	-	●
Voltage compensation	-	●
Monitoring of system parameters	●	●
SSR diagnostics	●	●
Load diagnostics	●	●
Overtemperature protection	●	●

It is not possible to mix RG..D..N and RG..CM..N in the same BUS chain.

The **NRG internal BUS cables** are proprietary cables that connect the NRG controller to the first RG..N in the NRG BUS chain and respective RG..Ns on the BUS. The internal BUS terminator, provided in the same package with the NRG controller, shall be plugged to the last RG..N in the NRG BUS chain.

## NRG system required components

Description	Component code	Notes
<b>Solid state relays</b>	RG..N	NRG solid state relays
<b>NRG controller</b>	NRGC..	<ul style="list-style-type: none"> <li>• <b>NRGC</b>: NRG controller with Modbus communication.</li> <li>• <b>NRGC-PN</b>: NRG controller with PROFINET communication.</li> <li>• <b>NRGC-EIP</b>: NRG controller with EtherNet/IP communication.</li> <li>• <b>NRGC-ECAT</b>: NRG controller with EtherCAT communication.</li> <li>• <b>NRGC-MBTCP</b>: NRG controller with Modbus TCP communication.</li> </ul> 1x RGN-TERMRES is included in the NRGC.. packaging. The RGN-TERMRES is to be mounted on the last RG..N on the bus chain.
<b>NRG internal BUS cables</b>	RCRGN-xxx	Proprietary cables terminated at both ends with a micro USB connector



## List of contents

### NRGC-PN

References .....	5
Structure .....	6
General data .....	7
Dimensions .....	7
Power supply specifications .....	7
Auto-addressing .....	8
Communications .....	9
Internal bus .....	9
Compatibility and conformance .....	10
Environmental specifications .....	11
LED indicators .....	11
Alarm management .....	12
Connection diagram .....	13
Mounting .....	14
Connection specifications .....	15

RCRGN .....	16
-------------	----

## References

### Order code





NRGC-PN

### Carlo Gavazzi compatible components

Description	Component code	Notes
<b>Solid state relays</b>	RG..CM..N	NRG solid state relays <ul style="list-style-type: none"> <li><b>RG..CM..N:</b> Communication interface for control of the RG..N and for real time monitoring. Maximum 32x RG..CM..N in one BUS chain.</li> </ul>
<b>NRG Internal BUS cables</b>	RCRGN-010-2	10cm cable terminated at both ends with a microUSB connector. Packed x4 pcs.
	RCRGN-025-2	25cm cable terminated at both ends with a microUSB connector. Packed x1 pc.
	RCRGN-075-2	75cm cable terminated at both ends with a microUSB connector. Packed x1 pc.
	RCRGN-150-2	150cm cable terminated at both ends with a microUSB connector. Packed x1 pc.
	RCRGN-350-2	350cm cable terminated at both ends with a microUSB connector. Packed x1 pc.
	RCRGN-500-2	500cm cable terminated at both ends with a microUSB connector. Packed x1 pc.

### Further reading

Information	Where to find it	
User manual NRG PROFINET	<a href="http://www.gavazziautomation.com/docs/mt_gh/SSR_UM_NRG_PN.pdf">http://www.gavazziautomation.com/docs/mt_gh/SSR_UM_NRG_PN.pdf</a>	
Datasheet RG..CM..N solid state relay with control and real time monitoring via bus	<a href="http://www.gavazziautomation.com/docs/mt_gh/SSR_RG_CM_N.pdf">http://www.gavazziautomation.com/docs/mt_gh/SSR_RG_CM_N.pdf</a>	
GSDML file	<a href="http://www.gavazziautomation.com/images/PIM/OTHERSTUFF/GSDML/GSDML_NRGC-PN.zip">http://www.gavazziautomation.com/images/PIM/OTHERSTUFF/GSDML/GSDML_NRGC-PN.zip</a>	

# Structure

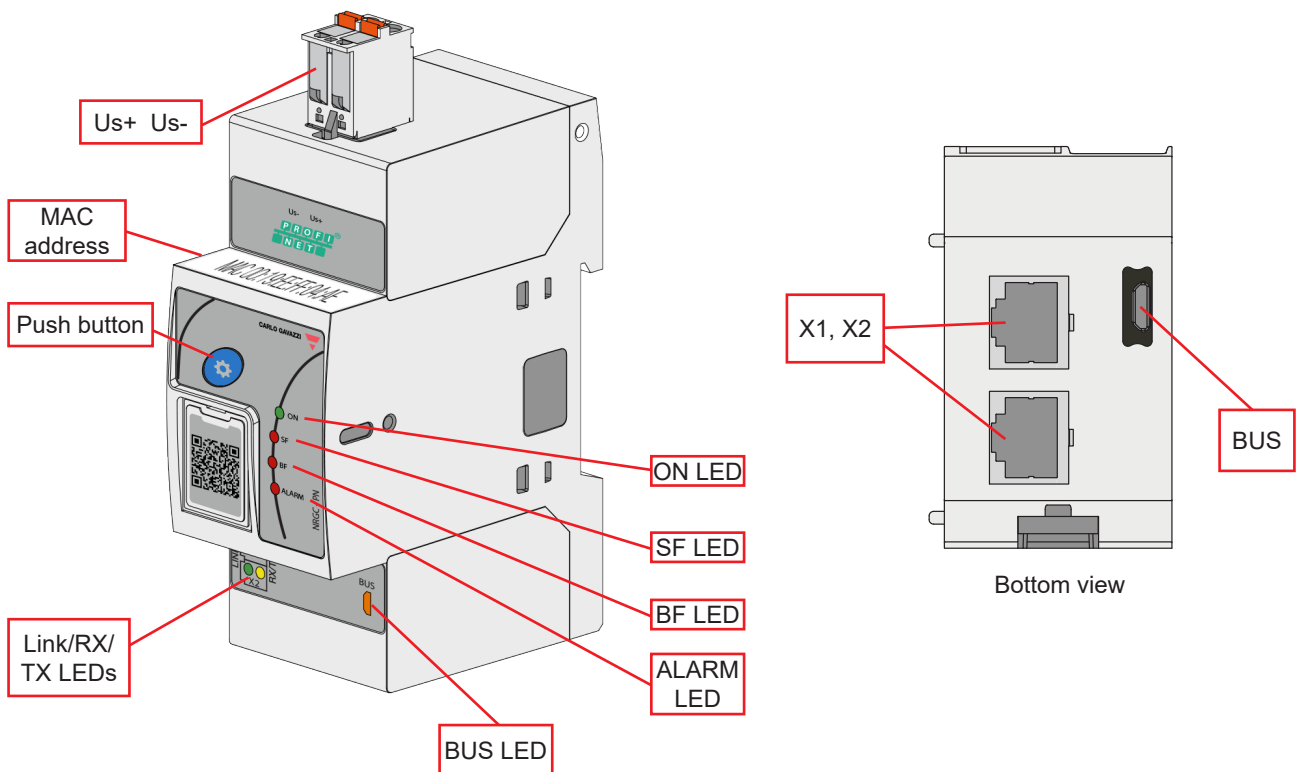

Element	Component	Function
<b>Us+ Us-</b>	Supply connection	2 position spring plug – Us-, Us+ connection for powering the NRGC-PN
<b>Push button</b>	Communications check & Autoaddressing button	Enables and disables a Communications Check function of the BUS chain (link between NRGC-PN and RG..Ns) by pressing front button between 2 to 5 seconds  Enables auto addressing of RG..Ns when pressed for 3 seconds during power up. Check 'Autoaddressing' section for more info.
<b>MAC address</b>	Device MAC address	Increment by 1 and 2 for MAC addresses of X1 and X2
<b>ON LED</b>	ON indicator	Indicates presence of Supply voltage on NRGC-PN
<b>BUS LED</b>	BUS indicator	Indicates ongoing communication with RG..Ns
<b>SF LED</b>	System Fault indicator	Indicates the presence of an alarm on the system
<b>BF LED</b>	Bus Fault indicator	Indicates issues with data exchange and PROFINET configuration
<b>ALARM LED</b>	ALARM indicator	Indicates presence of an alarm condition
<b>Link / RX / TX LEDs</b>	Link/Activity indicators	Indicates the status of the physical ethernet connection
<b>X1, X2</b>	PROFINET ports	2x RJ45 plugs for PROFINET communication
<b>BUS</b>	Micro-USB port – internal BUS	RCRGN cable connection for the internal BUS communications line

## Features

### General data

<b>Material</b>	Noryl (UL94 V0), RAL7035
<b>Mounting</b>	DIN rail
<b>Dimensions</b>	2-DIN
<b>Touch protection</b>	IP20, IP00 with door flap on front facade open
<b>Weight</b>	135 g
<b>Compatibility</b>	RGC..CM..N solid state contactors (RG end-devices) RGS..CM..N solid state relays (RG end-devices)

### Dimensions

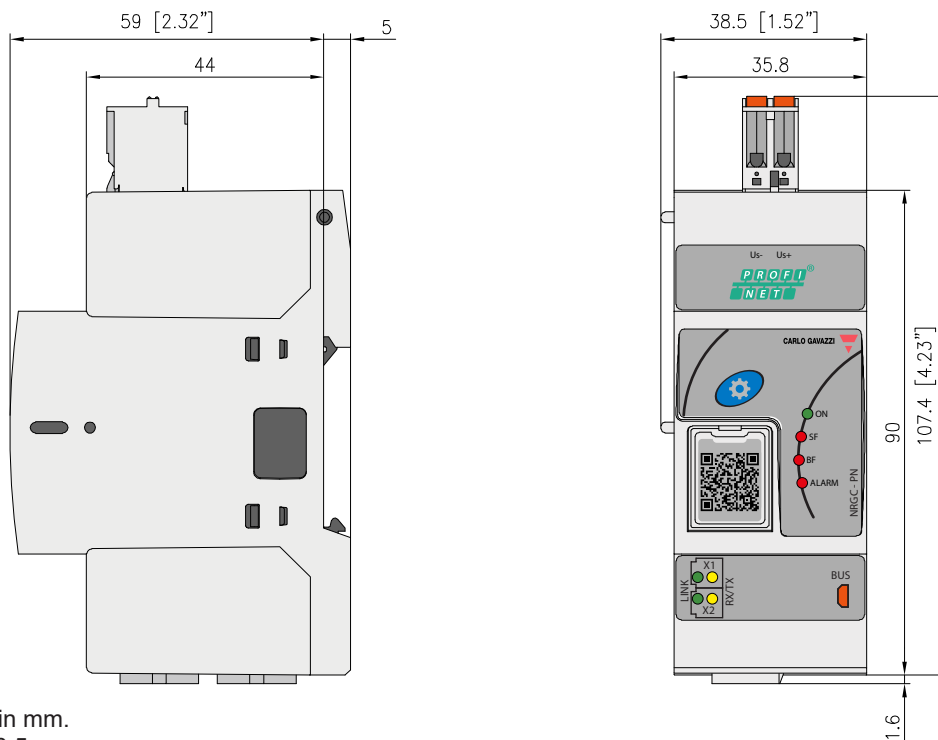

All dimensions in mm.  
Tolerances +/- 0.5 mm.

## Performance

### Power supply specifications

<b>Supply port rating, Us</b>	24 VDC
<b>Supply voltage range, Us</b>	19.2 – 32 VDC*
<b>Reverse polarity protection</b>	Yes
<b>Consumption</b>	< 12 W
<b>LED Indication, Supply ON</b>	Green LED
<b>Power on</b>	2 s

\* to be supplied by class 2 power source according to UL1310

## Auto-addressing

The RG..Ns on the bus chain are automatically addressed upon the first start-up of the system. The RG..Ns are addressed based on their position on the bus chain.

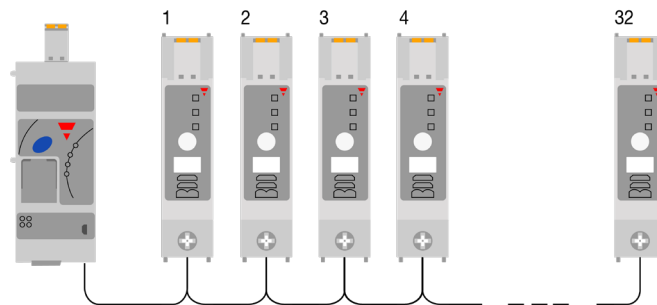

In case of an RG..N replacement, or any changes to the NRG bus chain, the RG..Ns have to be re-addressed. Follow the procedure below to re-address the RG..Ns on the NRG bus chain manually. Alternatively, auto-addressing can be done via an acyclic command (check NRG PROFINET User Manual for further information)

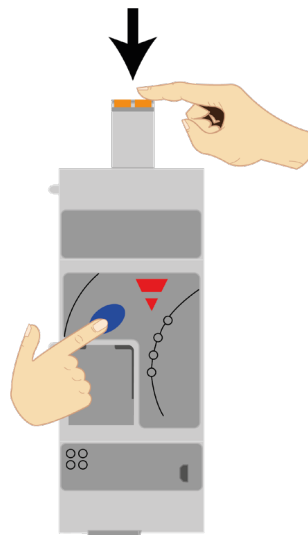

**Fig. 1** Hold the blue button while powering up the NRG-C-PN

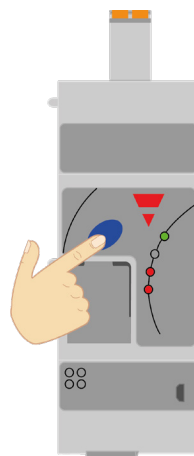

**Fig. 2** Release when Alarm LED turns ON indicating that autoaddressing is complete







## Communication

<b>Communication protocol to Main Controller</b>	PROFINET
<b>GSD file</b>	The PROFINET GSDML file for NRGC-PN is available electronically by going to <a href="http://www.gavazziautomation.com">www.gavazziautomation.com</a>
<b>Addressing</b>	The MAC address of the device is listed on the façade of the NRGC-PN. Each physical Ethernet Port (X1, X2) has its own MAC address. X1 uses the device MAC address incremented by one and for X2 increment the device MAC address by two.
<b>Connection to main controller</b>	The PROFINET ports (X1, X2) are 100 Mbit, full duplex operation ports and should be connected to another PROFINET device with Cat5e (straight through) cable via the standard RJ45 connector (maximum length 100 m). The interconnecting cables should be fitted with plugs provided with an outer metallic shell with the shell connected to the wire screen of the cable.
<b>LED indication - TX, RX</b>	Yellow, Flashing - NRGC-PN is sending/receiving Ethernet frames
<b>LED indication - Link</b>	Green, ON - Device is linked to Ethernet

## Internal Bus

<b>Max. number of RG..Ns connected to NRGC</b>	32x RG..CM..N
<b>Connection to RG..Ns</b>	RCRGN-xx 5-way cable terminated with micro-USB connection
<b>BUS termination</b>	RGN-TERMRES (1x pc. provided with 1x NRGC-PN) to be plugged on the last RG..N on the BUS chain to terminate the internal BUS
<b>LED indication - BUS</b>	Yellow, ON indicating ongoing communication with the RG end-devices

## Compatibility and Conformance

Approvals	   
Standards compliance	LVD: EN 60947-5-1 EMCD: EN 60947-5-1 EE: EN 60947-5-1 EMC: EN 60947-5-1 UL: UL508 (E172877), NMFT cUL: C22.2 No. 14 (E172877), NMFT7

Electromagnetic compatibility (EMC) - Immunity	
Electrostatic discharge (ESD)	EN/IEC 61000-4-2 8 kV air discharge, 4 kV contact (PC1)
Radiated radio frequency	EN/IEC 61000-4-3 10 V/m, from 80 MHz to 1 GHz (PC1) 10 V/m, from 1.4 to 2 GHz (PC1) 3 V/m, from 2 to 2.7 GHz (PC1)
Electrical fast transient (burst)	EN/IEC 61000-4-4 Input: 1 kV , 5kHz & 100kHz (PC1) Internal bus: 1 kV , 5kHz & 100kHz (PC1) PROFINET ports: 1 kV , 5kHz & 100 kHz (PC1) 2 kV , 5kHz & 100 kHz (PC2)
Conducted radio frequency	EN/IEC 61000-4-6 10 V/m, from 0.15 to 80 MHz (PC1)
Electrical surge	EN/IEC 61000-4-5 DC Output / Input, line to line: 500 V (PC2) DC Output / Input, line to earth: 500 V (PC2) Signal, line to earth 1 kV (PC2) <sup>1</sup>
Voltage dips and interruptions	EN/IEC 61000-4-11 0% @ 5000 ms (PC2) 40% @ 200 ms (PC2) 60% @ 10, 30, 100, 300, 1000 ms (PC2)
Voltage dips and interruptions on input lines	EN/IEC 61000-4-29 0% @ 1, 3, 10, 30, 100, 300, 1000 ms (PC2) 30% @ 10, 30, 100, 300, 1000 ms (PC2) 70% @ 10, 30, 100, 300, 1000 ms (PC2) 80% @ 10, 30, 100, 300, 1000 ms, 3 s, 10 s (PC2) 120% @ 10, 30, 100, 300, 1000 ms, 3 s, 10 s (PC2)







1. Not applicable to shielded cables <10m. Additional suppression on data lines may be required if shielded cables are not used.

Electromagnetic compatibility (EMC) - Emissions	
Radio interference field emissions (radiated)	EN/IEC 55011 Class A: from 30 to 1000 MHz
Radio interference voltage emissions (conducted)	EN/IEC 55011 Class B: from 0.15 to 30 MHz

### Environmental specifications

Operating temperature	-20 to +65 °C (-4 to +149 °F)
Storage temperature	-20 to +65 °C (-4 to +149 °F)
Relative humidity	95% non-condensing @ 40°C
Pollution degree	2
Installation altitude	0 - 2000m
EU RoHS compliant	Yes
China RoHS	

### LED indicators

ON	Green 	ON:	Us is present at terminals Us+, Us-
		OFF:	Us is not present at terminals Us+, Us-
Link (X1 & X2)	Green 	ON:	Device is linked to Ethernet
		OFF:	Device has no link to Ethernet
BUS	Yellow 	ON:	During transmission of messages from NRGC-PN to RG..Ns
		OFF:	Idle bus between the NRGC-PN and RG..Ns and when NRGC-PN is receiving data from RG..Ns
TX/RX (X1 & X2)	Yellow 	OFF:	No frames are being sent/received
		Flashing:	NRGC-PN is sending/receiving Ethernet frames
ALARM	Red 	ON:	Flashing when alarm condition on NRGC-PN is present. Refer to Alarm management section
		OFF:	No alarm condition
SF	Red 	ON:	Alarm is present in the system
		OFF:	No error
		Flashing:	DCP signal service is initiated
BF	Red 	ON:	No configuration
		OFF:	No error
		Flashing:	No data exchange

## Alarm management

<b>Alarm condition present</b>	<ul style="list-style-type: none"> <li>• ALARM LED ON with a specific flashing rate</li> <li>• Alarms are available as diagnostics messages via the PROFINET Diagnostic System. Refer to NRG PROFINET User Manual for further information</li> </ul>	
<b>Alarm types</b>	<b>No. of flashes</b>	<b>Description of fault</b>
	2	Errors in the configurations of the internal NRG bus chain including: <ul style="list-style-type: none"> <li>• Number of RG..Ns on bus chain is &gt; 32 (Device Limit Error)</li> <li>• More than one RG..N on the bus chain have the same address (Device conflict error)</li> <li>• One of the RG..Ns does not have an address this may occur when a new RG..N is introduced to the bus chain (Device Unconfigured Error)</li> <li>• The internal Device ID of one of the RG..Ns on the bus chain does not correspond to its position on the bus (Device Position Error)</li> </ul>
	4	Supply Error: Supply to NRGC-PN is outside of the specified range
	8	Communication Error (BUS): An error in the communication link (internal BUS) between the NRGC-PN and RG..Ns
	9	Internal Error: Detection of internal issues with the NRGC-PN
<b>Flashing rate</b>		

## ▶ Connection diagram

The NRG bus chain can be configured in a PROFINET network via a line, ring (support of Media Redundancy Protocol), star or tree topologies via the ethernet ports on the NRGC-PN.

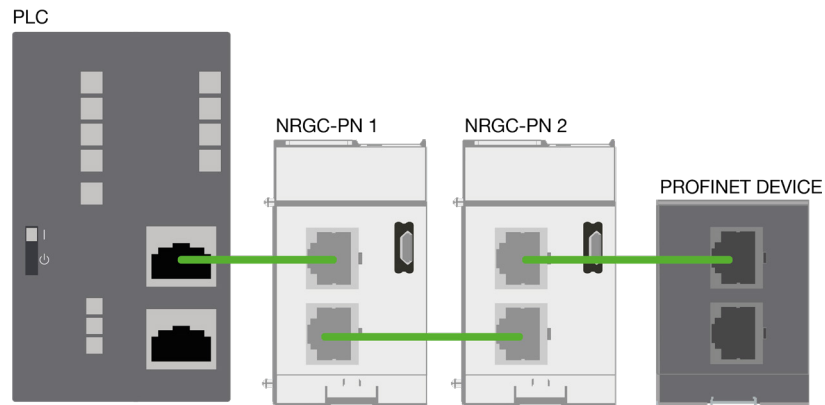

**Fig. 3** Example of a line configuration of the NRGC-PN with other PROFINET devices and controller

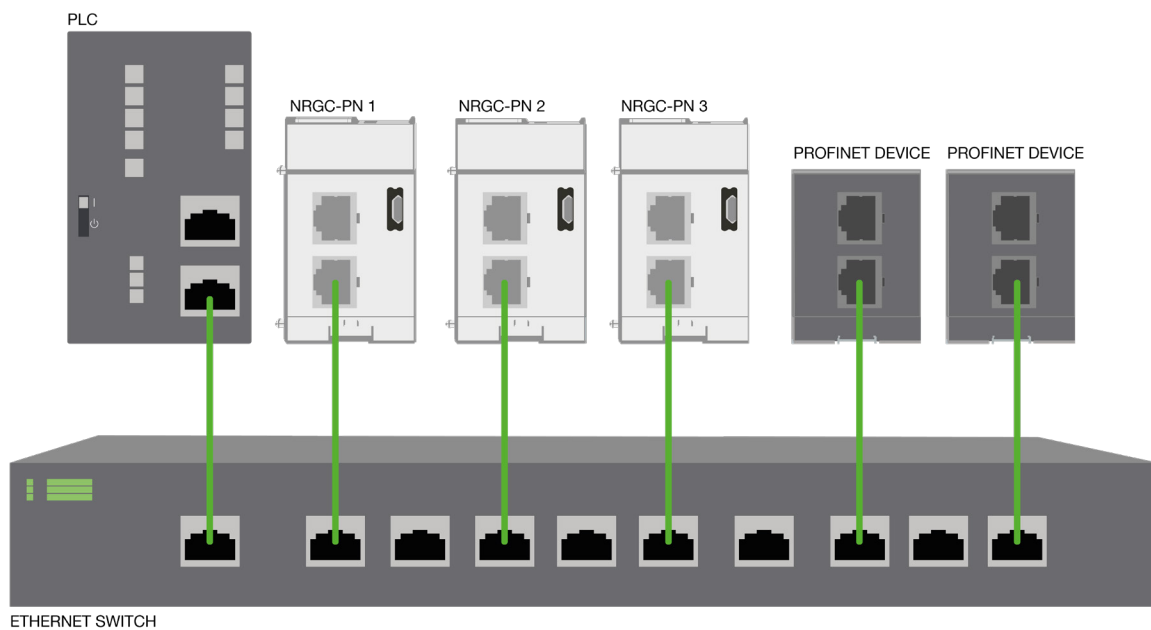
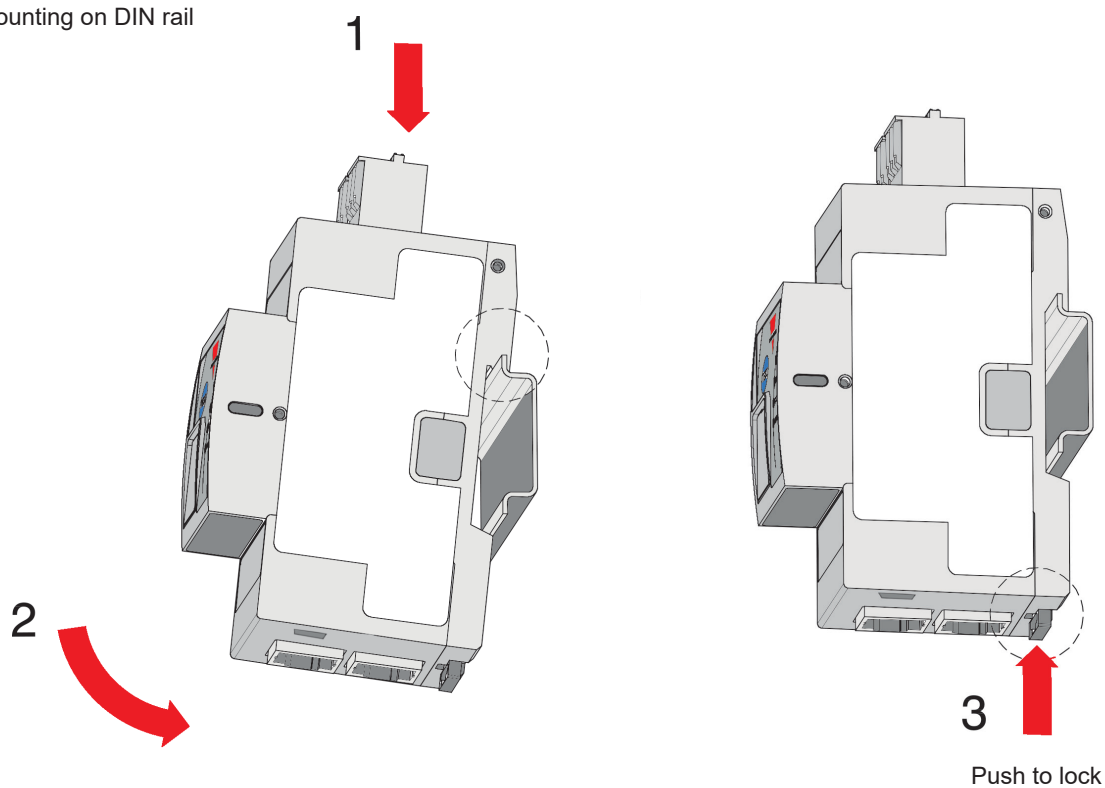

**Fig. 4** Example of a star configuration of the NRGC-PN with other PROFINET devices and controller



## ▶ Mounting

Mounting on DIN rail



Dismounting from DIN rail

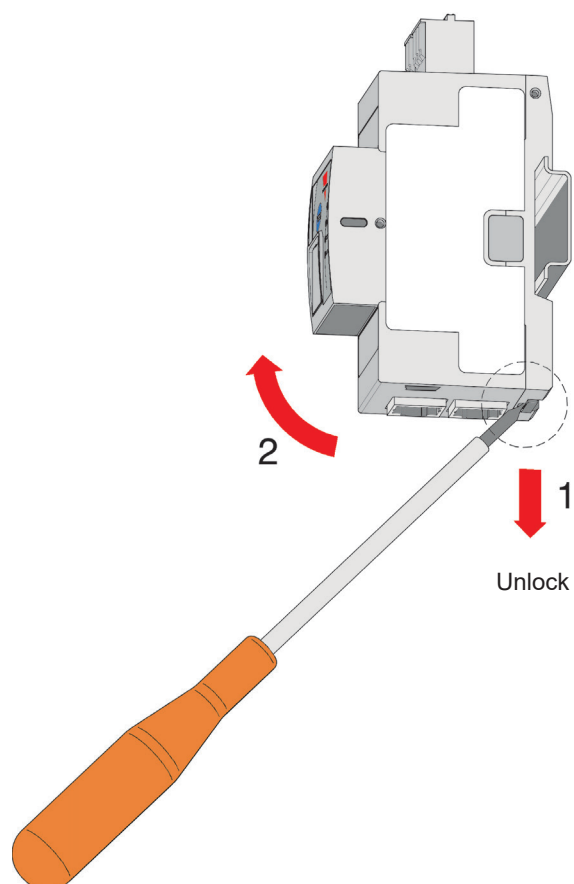

## Connection specifications

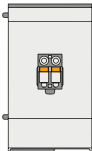
Power connection	
Terminal	Supply: Us+, Us-
	 Top view
Conductors	Use 60/75°C copper (Cu) conductors
Stripping length	12 - 13 mm
Connection type	2-pole spring plug, pitch 5.08 mm
Rigid (solid & stranded) UL/CSA rated data	0.2 – 2.5 mm <sup>2</sup> , 26 – 12 AWG
Flexible with end sleeve	0.25 – 2.5 mm <sup>2</sup>
Flexible without end sleeve	0.25 – 2.5 mm <sup>2</sup>
Flexible with end sleeve using TWIN ferrules	0.5 – 1.0 mm <sup>2</sup>

Communication - connection	
Terminal	X1, X2: RJ45 (x2) BUS: RCRGN-xxx-2
	 Bottom view
PROFINET connection	RJ45 shielded plugs
Cable for PROFINET	Not provided. Shielded CAT-5e straight cables.
Max. length of ethernet cable	100 mtrs (between PROFINET devices)
Cable for Internal Bus	RCRGN-xxx-2: 5-way USB micro connection - +24 supply line for RG..Ns - GND - RS485A - RS485B - Autoconfig / Auto addressing line

# RCRGN..

## NRG internal BUS cable



### Main features

- Cables available at various lengths to provide the internal BUS of the NRG system
- Cables terminated at both ends with a microUSB plug
- Connects the NRG controller to the RG..N solid state relay and respective RG..N solid state relays

### Description

The **RCRGN** cables are proprietary cables that must be used with the NRG system for the internal BUS. These cables connect the NRG controller to the RG..N solid state relays and respective RG..N solid state relays.

The RCRGN.. are 5-way cables carrying the communication, supply and autocofiguration lines. By means of autoconfiguration, the RG..Ns are assigned a unique ID based on the physical location and hence internal BUS wiring sequence when an autoconfiguration command is sent to the RG..Ns.

### Carlo Gavazzi compatible components

Description	Component code	Notes
<b>NRG Controller</b>	NRGC..	<ul style="list-style-type: none"> <li>• <b>NRGC</b>: NRG controller with Modbus communication.</li> <li>• <b>NRGC-PN</b>: NRG controller with PROFINET communication.</li> <li>• <b>NRGC-EIP</b>: NRG controller with EtherNet/IP communication.</li> <li>• <b>NRGC-ECAT</b>: NRG controller with EtherCAT communication.</li> <li>• <b>NRGC-MBTCP</b>: NRG controller with Modbus TCP communication</li> </ul> 1x RGN-TERMRES is included in the NRGC.. packaging. The RGN-TERMRES is to be mounted on the last RG..N on the bus chain.
<b>Solid state relays</b>	RG..N	NRG solid state relays

### Order code

 **RCRGN -  - 2**

Enter the code entering the corresponding option instead of

Code	Option	Description	Notes	
R	-	Cables		
C	-			
R	-			
G	-		Suitable for the NRG system	
N	-			
<input type="checkbox"/>	010		10 cm cable length	packed x 4 pcs.
	025	25 cm cable length	packed x 1 pc.	
	075	75 cm cable length	packed x 1 pc.	
	150	150 cm cable length	packed x 1 pc.	
	350	350 cm cable length	packed x 1 pc.	
	500	500 cm cable length	packed x 1 pc.	
2	-	Terminated at the both ends with a microUSB connector		





COPYRIGHT ©2022  
Content subject to change.  
Download the PDF: <http://gavazziautomation.com>