

Electromagnetic safety interlock with separated actuator



Benefits

- **Enhancing safety.** Ideal for applications that require access to remain closed and locked until potential hazards have stopped or come to a predetermined safe state.
- **Easy to install and cost effective.** Protecting machines from interruptions in production.
- **Standards compliance.** SIL 3 in accordance with EN 62061, PL e in accordance with EN ISO 13849-1, interlock type 2 in accordance with EN ISO 14119.
- **High performance.** Reinforced polymeric casing with a protection degree IP65, operation range from -25°C to +55°C, retention force 1200N.
- **Approvals** by IMQ, CE, cULus.

Description

The Carlo Gavazzi safety switches are devices designed and manufactured in accordance with IEC international standards and EN European regulations.

This device is used on machines where the hazardous conditions remain for a while after the stop signal generation and is helpful for the realization of safety systems in accordance with ISO 14119, performing a personal protection function.

Applications

This device is useful for guarantee the safety of the operator in case of machines where the hazardous conditions remains for a while time after the generation of the stop signal, because of the mechanical inertia of moving parts, components under pressure or with high temperatures.

Main functions

- Ensure protection in inertia's machineries
- Prevents the entry in a dangerous area until the unlock signal
- With manual unlock device for emergency
- Block controlled by solenoid
- Signals generated by solenoid or actuator
- Without electronic PCB

References

▶ Order code

ESI 1 024

Enter the code option instead of

| Code | Option | Description |
|--------------------------|--------|---|
| E | - | Electromagnetic |
| S | - | Safety |
| I | - | Interlock |
| <input type="checkbox"/> | 31 | 3NC (1NC actuator, 2NC solenoid) + 1NO (solenoid) |
| | 22 | 2NC (solenoid) + 2NO (1NO actuator, 1NO solenoid) |
| | 13 | 1NO (actuator) + 3NC (1NC actuator, 2NC solenoid) |
| 1 | - | Head orientation: frontal |
| <input type="checkbox"/> | E | Electrical block |
| | M | Mechanical block |
| 024 | - | 24 Vac/dc |

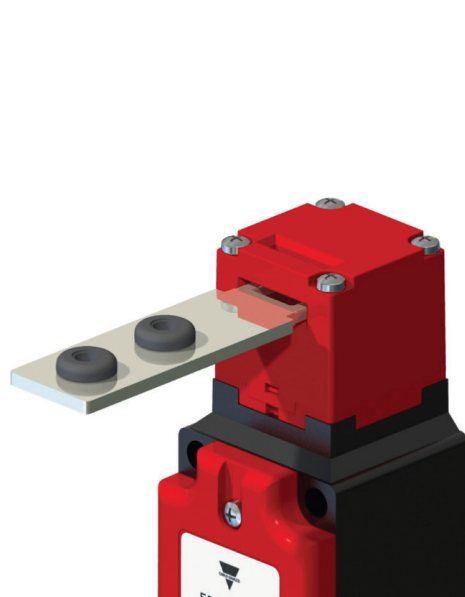

Fig. 1 Head orientation

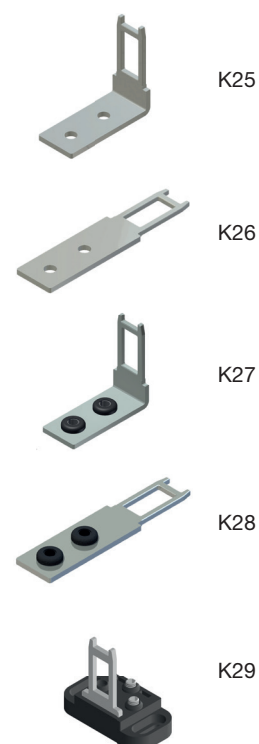

Fig. 2 Actuators (to be ordered separately)

Selection guide: electrical interlock

| Part number | Electrical interlock | Coil |
|-------------|-----------------------------------|----------|
| ESI311E024 | 1NO + 2NC (Coil) + 1NC (Actuator) | 24Vac/dc |
| ESI221E024 | 1NO + 2NC (Coil) + 1NO(Actuator) | 24Vac/dc |
| ESI131E024 | 2NC (Coil) + 1NO + 1NC (Actuator) | 24Vac/dc |



Selection guide: mechanical interlock

| Part number | Mechanical Interlock | Coil |
|-------------|-----------------------------------|----------|
| ESI311M024 | 1NO + 2NC (Coil) + 1NC (Actuator) | 24Vac/dc |
| ESI221M024 | 1NO + 2NC (Coil) + 1NO(Actuator) | 24Vac/dc |
| ESI131M024 | 2NC (Coil) + 1NO + 1NC (Actuator) | 24Vac/dc |

CARLO GAVAZZI compatible components

| Purpose | Component name/code | Notes |
|----------------|---------------------|-------|
| Safety modules | CM | - |
| Safety module | CMM | - |
| Safety modules | SMS | - |

Further reading

| Information | Where to find it | QR |
|--------------------|---|---|
| Instruction manual | http://www.productselection.net/MANUALS/UK/ESI_IM.pdf |  |
| SISTEMA Libraries | http://www.gavazzi-automation.com/nsc/HQ/EN/safety_modules |  |

Structure

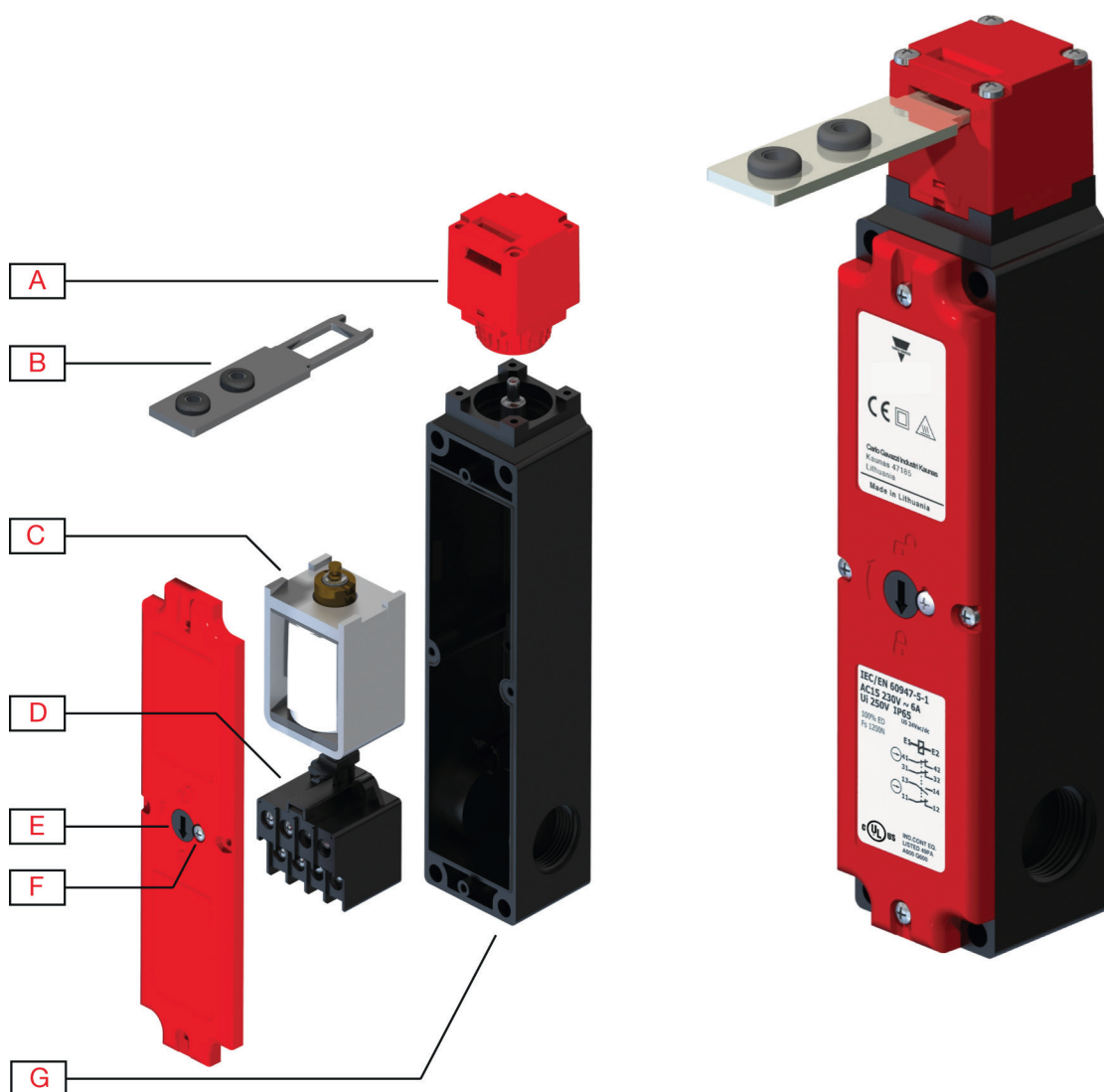

| Element | Component |
|---------|------------------------------------|
| A | Operating head |
| B | Actuator* |
| C | Solenoid |
| D | Contact block |
| E | Manual unlock device |
| F | Release device with security screw |
| G | 3x M20 cable inlet |

* To be ordered separately (fig. 2)

Features

General

| | |
|---------------|-----------|
| Casing | Polimeric |
| Weight | 440g |

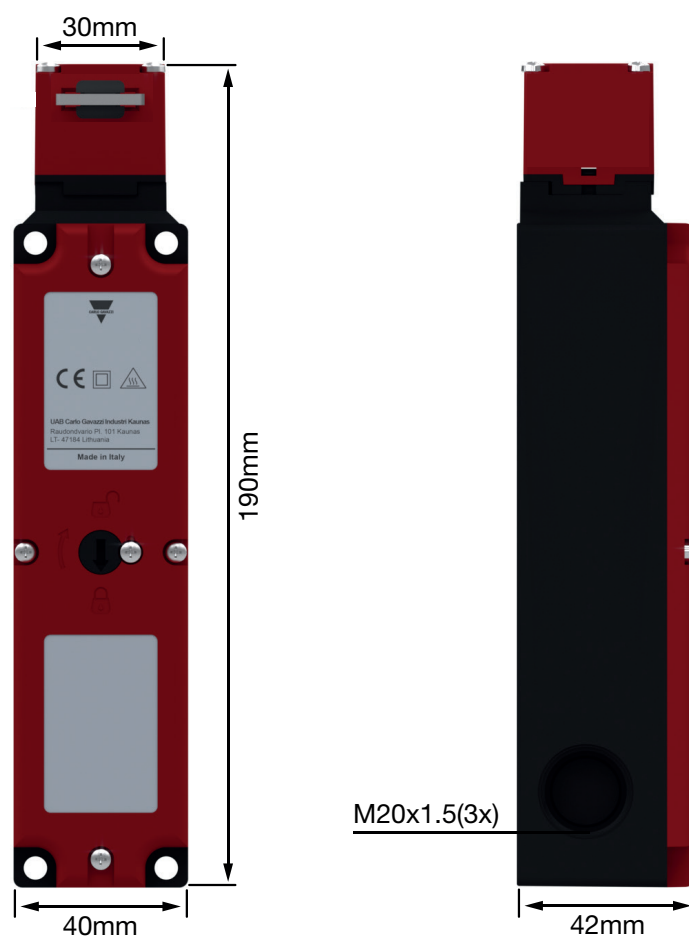

Performance

| | |
|---|-------------------------|
| Max actuating speed | 20 m/min |
| Switching frequency | 600 cycles/h |
| Retention force at locked actuator | 1200N |
| Resistance between contacts | 25 mΩ |
| Mechanical durability | 1 million of operations |
| B10d | 4 million of operations |

Contact block



| | |
|---|-----------|
| Rated impulsive withstand voltage Uimp | 2,5 kV |
| Conventional free air thermal current Ith | 10A |
| Rated operating current AC-15 | 24V - 10A |
| Rated operating current AC-15 | 230V - 4A |
| Rated operating current DC-13 | 24V - 4A |

Connection specifications

| | |
|----------------------|----------------------------|
| Connecting terminals | M3 screws with cable clamp |
| Wiring dimensions* | 0.34 - 1.5 mm ² |

* Use only copper conductors 60/70°C, AWG14-18, stranded and solid conductor. Clamps tightening torque 0.8Nm.

Compatibility and conformity

| | |
|---------------------|---|
| Standard compliance | Low Voltage Directive 2014/35/EU in accordance with EN/IEC 60947-5-1 Machinery Directive 2006/42/CE in accordance with EN ISO 14119 SIL 3 in accordance with EN 62061 PL e in accordance with EN ISO 13849-1 Interlock type 2 in accordance with EN ISO 14119 |
| Terminal marking | In accordance with IEC 60947-5-1 |
| Approvals |    |

Environmental

| | |
|---|------------------|
| Operating temperature | -25 ÷ 55°C |
| Environmental designation | Type-1 enclosure |
| Protection against electrical shock | Classe II |
| IP protection degree | IP65 |
| Rated insulation voltage Ui | 250V |
| Utilization category according to UL508 | A300 - Q300 |

Electrical interlock

- Actuator locked when the solenoid is activated.
- The release is possible by switching off the power supply.

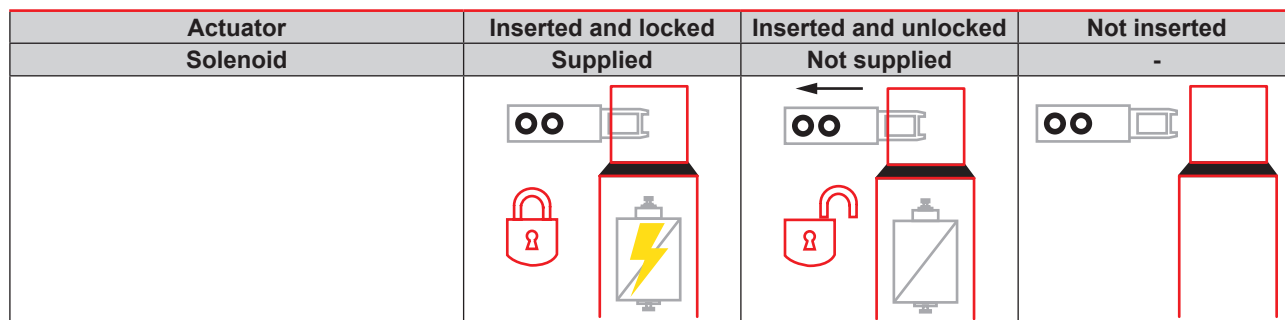

| Type | Actuation | 11 | 12 | 21 | 22 | 33 | 34 | 41 | 42 | 13 | 14 | 21 | 22 | 33 | 34 | 41 | 42 | 13 | 14 | 21 | 22 | 31 | 32 | 41 | 42 |
|-------|--------------|----|----|----|----|----|----|----|----|----|----|----|----|----|----|----|----|----|----|----|----|----|----|----|----|
| ESI31 | 1NC actuator | 11 | | 12 | | | | | | | | | | | | | | | | | | | | | |
| | 1NC solenoid | 21 | | 22 | | | | | | | | | | | | | | | | | | | | | |
| | 1NO solenoid | 33 | | 34 | | | | | | | | | | | | | | | | | | | | | |
| | 1NC solenoid | 41 | | 42 | | | | | | | | | | | | | | | | | | | | | |
| ESI22 | 1NO actuator | 13 | | 14 | | | | | | | | | | | | | | | | | | | | | |
| | 1NC solenoid | 21 | | 22 | | | | | | | | | | | | | | | | | | | | | |
| | 1NO solenoid | 33 | | 34 | | | | | | | | | | | | | | | | | | | | | |
| | 1NC solenoid | 41 | | 42 | | | | | | | | | | | | | | | | | | | | | |
| ESI13 | 1NO actuator | 13 | | 14 | | | | | | | | | | | | | | | | | | | | | |
| | 1NC solenoid | 21 | | 22 | | | | | | | | | | | | | | | | | | | | | |
| | 1NC solenoid | 31 | | 32 | | | | | | | | | | | | | | | | | | | | | |
| | 1NC actuator | 41 | | 42 | | | | | | | | | | | | | | | | | | | | | |

Attention: in case of lack of voltage the device allows the immediate access to the protected area

Mechanical interlock

- Actuator locked when the solenoid is not activated.
- The release is possible by supplying the device.

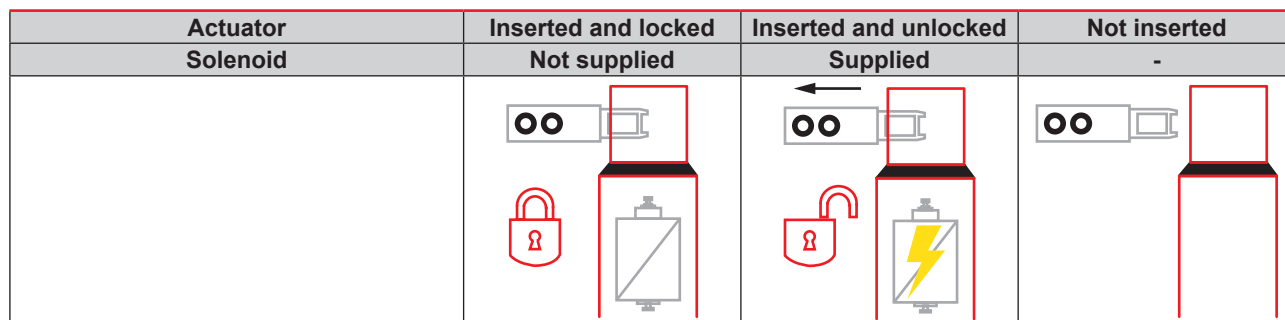

| Type | Actuation | 11 | 12 | 21 | 22 | 33 | 34 | 41 | 42 |
|-------|--------------|----|----|----|----|----|----|----|----|
| ESI31 | 1NC actuator | 11 | 12 | 21 | 22 | 33 | 34 | 41 | 42 |
| | 1NC solenoid | 21 | 22 | 33 | 34 | 41 | 42 | 11 | 12 |
| | 1NO solenoid | 33 | 34 | 41 | 42 | 11 | 12 | 21 | 22 |
| | 1NC solenoid | 41 | 42 | 11 | 12 | 21 | 22 | 33 | 34 |
| ESI22 | 1NO actuator | 13 | 14 | 21 | 22 | 33 | 34 | 41 | 42 |
| | 1NC solenoid | 21 | 22 | 33 | 34 | 41 | 42 | 13 | 14 |
| | 1NO solenoid | 33 | 34 | 41 | 42 | 13 | 14 | 21 | 22 |
| | 1NC solenoid | 41 | 42 | 13 | 14 | 21 | 22 | 33 | 34 |
| ESI13 | 1NO actuator | 13 | 14 | 21 | 22 | 31 | 32 | 41 | 42 |
| | 1NC solenoid | 21 | 22 | 31 | 32 | 41 | 42 | 13 | 14 |
| | 1NC solenoid | 31 | 32 | 41 | 42 | 13 | 14 | 21 | 22 |
| | 1NC actuator | 41 | 42 | 13 | 14 | 21 | 22 | 31 | 32 |



COPYRIGHT ©2020
Content subject to change. Download the PDF: www.gavazziautomation.com