

Conductive Sensors 2 to 4-point level controller Type CL with potentiometer

CARLO GAVAZZI



- Conductive level controller
- Adjustment of sensitivity – operating resistance from 250Ω to 500KΩ
- Multiple combinations of filling and emptying applications
- Low-voltage AC electrodes
- Easy installation on DIN rails or with 11 pin circular plug
- Rated operational voltage:
24 VAC/DC, 115 VAC or 230 VAC
- Output 2x8A/250 VAC SPDT relay
- LED indication for: Output ON and Power ON



Product Description

μ-Processor based level controller for liquids with a wide sensitivity range (like sewage water, chemicals, salt water etc.). The controller has a separate output for alarm indication in case of a tank

running dry or if an overflow condition occurs.
8A SPDT/SPST relay output, NO/NC.
Sensitivity control by potentiometer level in 3 ranges.

Ordering Key

CLD4MA2DM24

Type _____
 DIN rail mounting _____
 Inputs _____
 Function _____
 Adjustment _____
 Outputs _____
 Relay versions _____
 Power supply _____

Type Selection

Mounting	Relay	Ordering no. Supply: 24 VAC/DC	Ordering no. Supply: 115 VAC	Ordering no. Supply: 230 VAC
DIN-rail	SPDT + SPST	CLD4MA2DM24	CLD4MA2D115	CLD4MA2D230
11-p circular plug	2 SPST	CLP4MA2AM24	CLP4MA2A115	CLP4MA2A230

Specifications

Rated operational voltage (U_B)					
Pin 2 & 10	230	195 to 265 VAC, 45 to 65 Hz			Ranges H (High sensitivity)
	115	98 to 132 VAC, 45 to 65 Hz			50 KΩ to 500 KΩ, C _F * = 1.0 nF
Supply class 2	24	19.2 to 28.8 VAC/DC			Dielectric voltage
Rated insulation voltage		<2.0 kVAC (rms)			>2.0 KVAC (rms) (contacts / electronics)
Rated impulse withstand voltage		4 kV (1.2/50 μs) (line/neutral)			Rated impulse withstand volt.
					4 kV (1.2/50 μs) (contacts / electronics) (IEC 664)
Rated operational power					Operating frequency (f)
AC supply	5 VA				Relay output
AC/DC supply	5 VA / 5 W				0.5 HZ
Delay on operate (t_v)	< 300 mS				Response time
Outputs		Make or break on rotary-switch			OFF-ON (t _{on})
Rated insulation voltage		250 VAC (rms) (cont./elec.)			ON-OFF (t _{off})
					1 s
Relay Rating (AgCdO)					1 s
Resistive loads	AC1	μ (micro gap)			Environment
	DC1	8 A / 250 VAC (2500 VA)			Overvoltage category
		1 A / 250 VDC (250 W)			III (IEC 60664)
		or 10 A / 25 VDC (250 W)			Degree of protection
Small induc. Loads	AC15	0,4 A / 250 VAC			IP 20 (IEC 60529, 60947-1)
	DC13	0,4 A / 30 VDC			Pollution degree
Mechanical life (typical)		≥ 30 x 10 ⁶ operations			2 (IEC 60664/60664A, 60947-1)
		@ 18'000 imp/h			Temperature
Electrical life (typical)	AC1	> 250'000 operations			Operating
					-20° to +50°C (-4° to + 122°F)
Level probe supply					Storage
Max. 5 VAC					-50° to +85°C (-58° to +185°F)
Level probe current					Housing material
Max. 2 mA					CLP
					NORYL PPO, light grey
Sensitivity					CLD
					ABS VO, light grey
250Ω to 500KΩ					Weight
Factory settings standard range "S" 100KΩ					AC supply
250 Ω to 5 KΩ, C _F * = 4.7 nF					200 g
Ranges L (Low sensitivity)					AC/DC supply
Ranges S (Standard sensitivity)					125 g
5 KΩ to 100 KΩ, C _F * = 2.2 nF					Approvals
					UL
					CSA
					cULus
					UL508, UL325, CSA-C22.2 No.247
					CE marking
					Yes

*C_F = maximum Cable Capacitance

Specifications are subject to change without notice (20.05.2014)

Mode of Operation

Connection cable

2, 3, 4 or 5 conductor PVC cable, normally screened. Cable length: max. 100 m. The resistance between the cores and the ground must be at least 500k. Normally, it is recommended to use a screened cable between probe and controller, e.g. where the cable is placed in parallel to the load cables (mains). The screen has to be connected to Y5 (reference).

Example 1

The diagram shows the level control connected as max. and min. control, i.e. registration of 2 levels + 2 alarm levels. The relays

react to the low current created when the electrodes are in contact with the liquid.

The reference (Ref) must be connected to the container or if the container consists of a non-conductive material, to an additional electrode. (To be connected to pin Y5).

In the diagram this electrode is shown by the dotted line.)

The alarm outputs utilize alarm - and Y1 for LoLo alarm - and Y4 for HiHi alarm outputs.

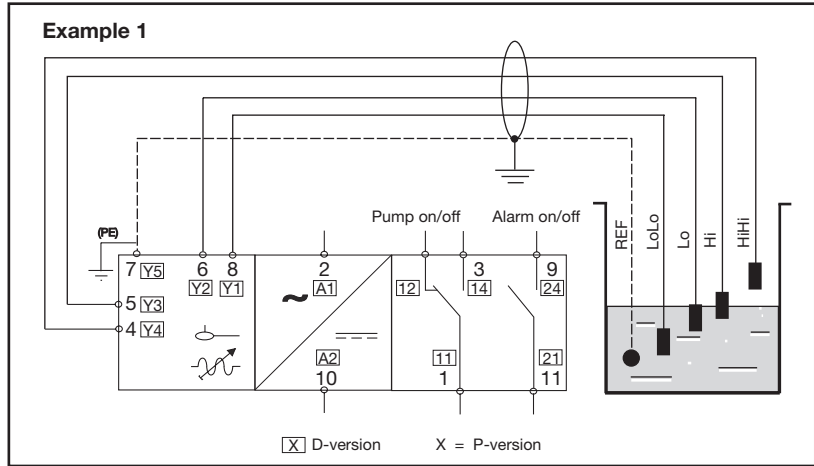

Operation Diagram

Function: Filling or Emptying

The Multifunction Controller can be used as a minimum-maximum control for two systems, a filling system and a emptying system, with the same kind of liquid to be measured and one common pump.

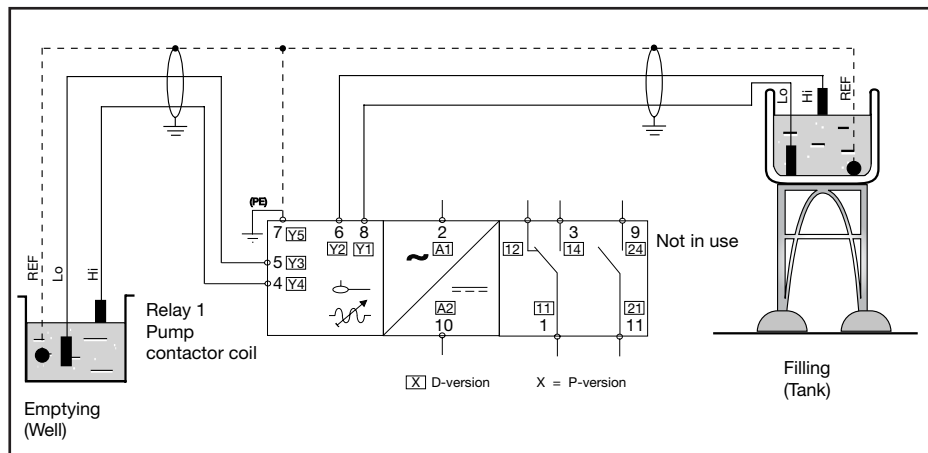

Tank-Well application (Filling and emptying)

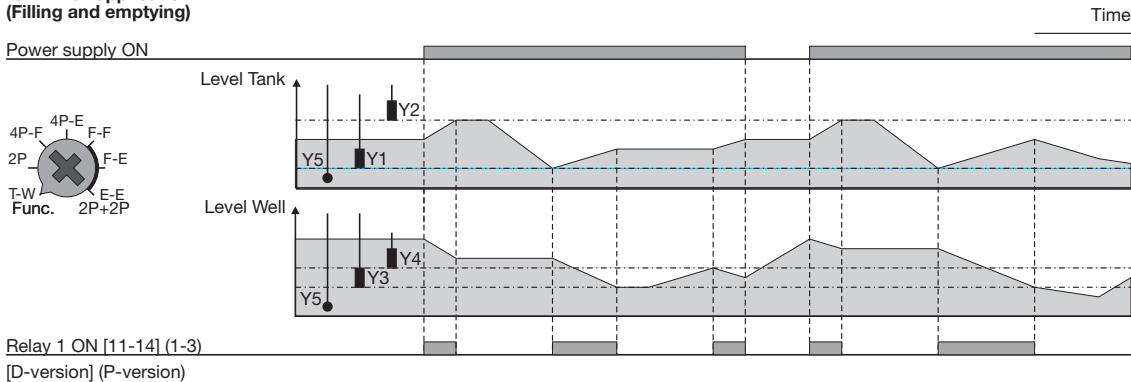

Operation Diagram

Function: Direct input- output
 The Multifunction Controller can be used as direct input/ output, where each of the two inputs (electrodes) controls an individual relay output:
 Electrode no. 1 = Relay no. 1
 Electrode no. 2 = Relay no. 2.

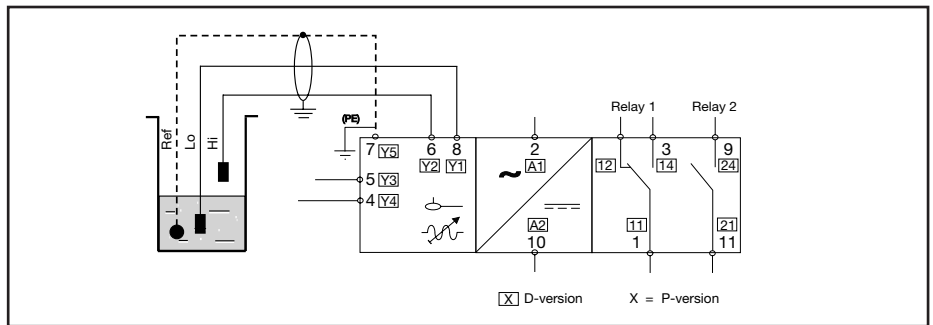

2-Probe (Direct Input to output)

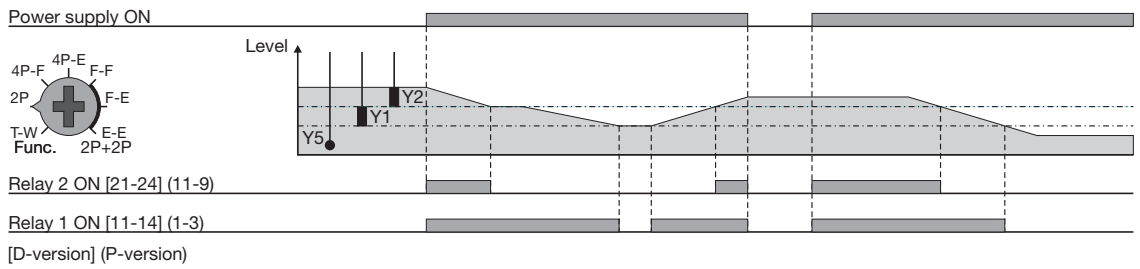

Function: Filling or Emptying with high and low alarms
 The Multifunction Controller can be used as a minimum-maximum control filling or emptying system, with HiHi and LoLo Alarm output.

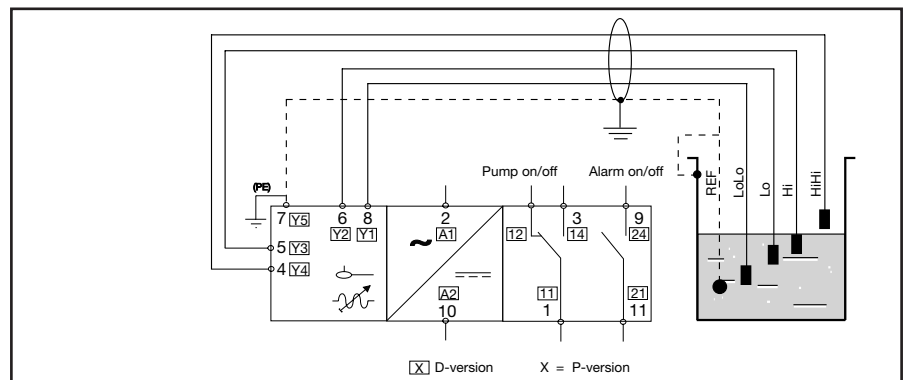

4-Probe Filling (Low and High alarm)

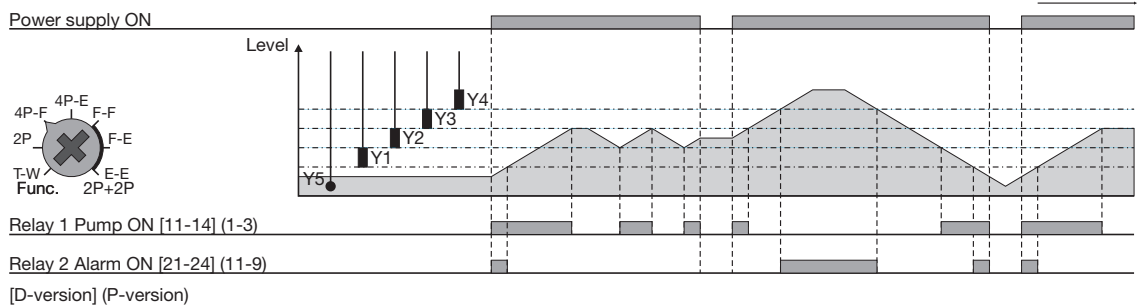

4-Probe Emptying (Low and High alarm)

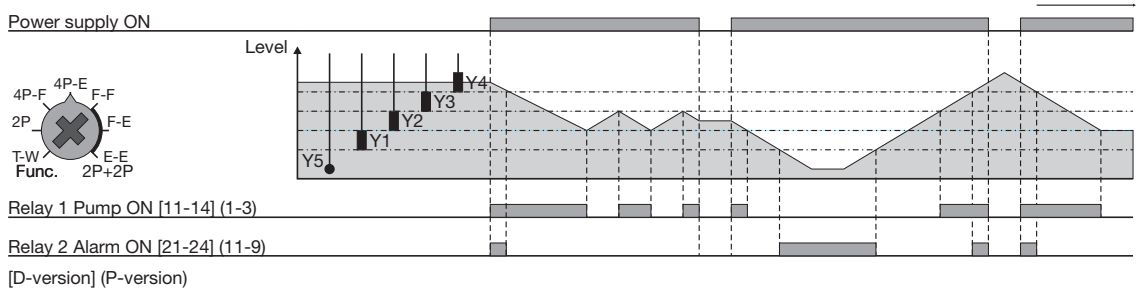

Operation Diagram

Function: Filling or Emptying
 The Multifunction Controller can be used as a minimum-maximum control for up to two individual systems, with the same kind of liquid to be measured.

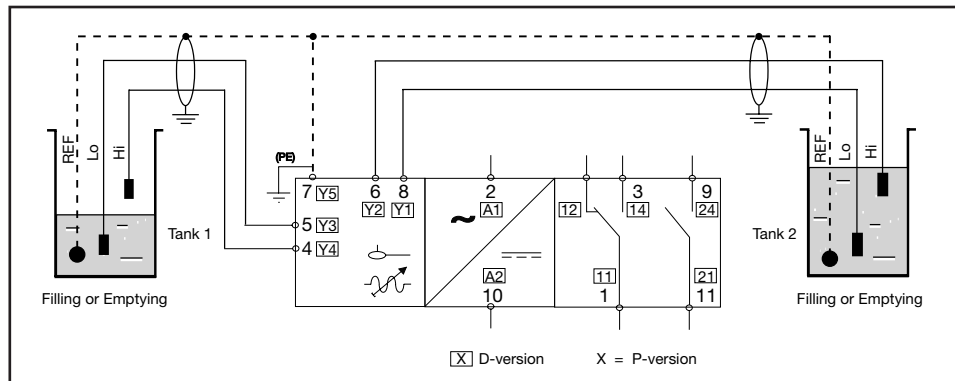

2 Individual systems (Filling and/or emptying)

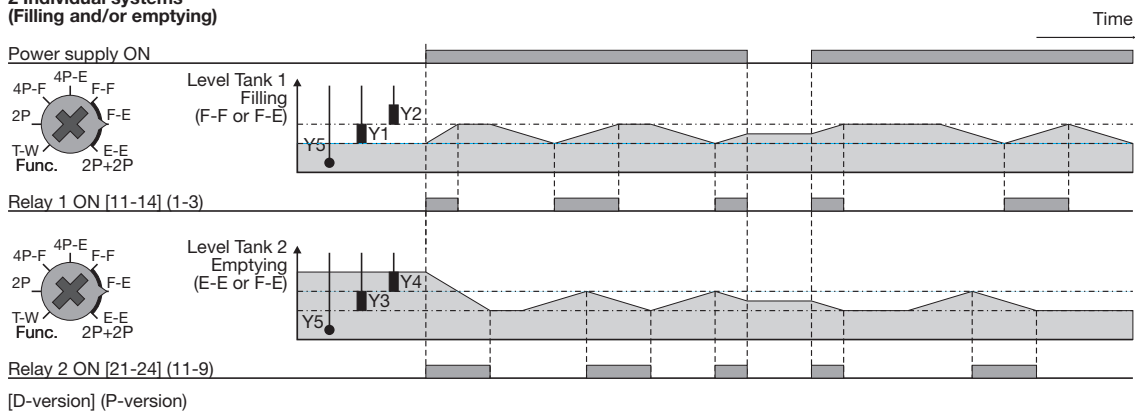

Wiring Diagram

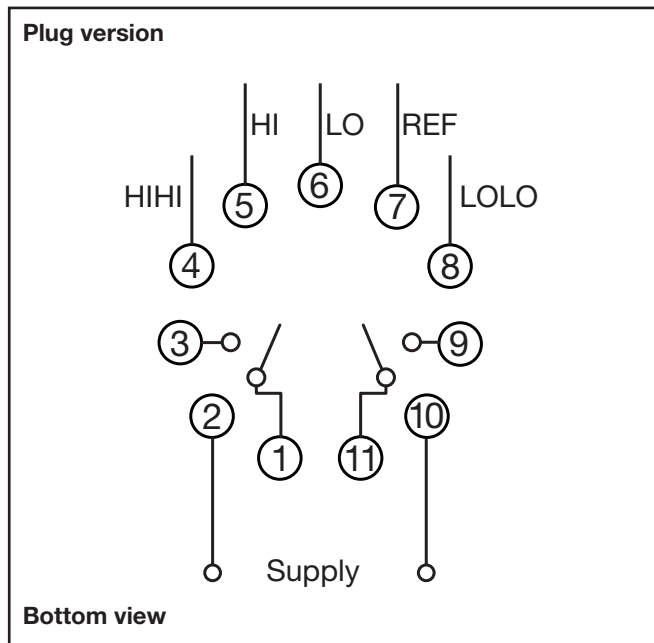
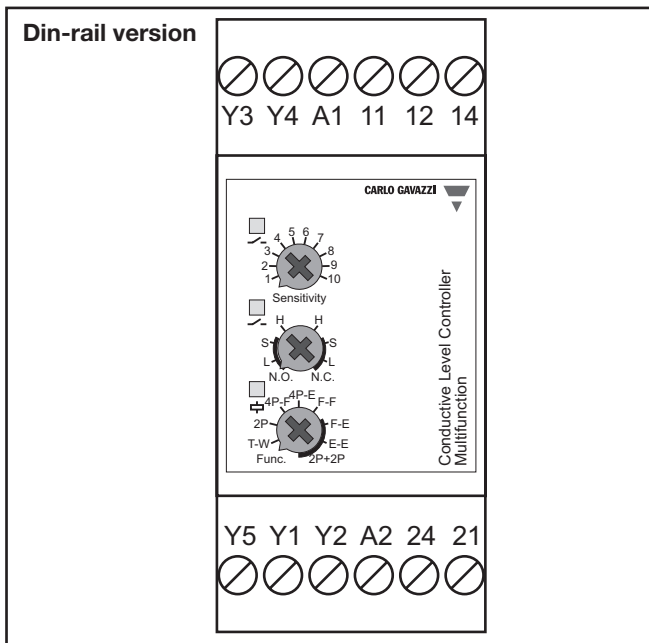

Dimension Drawings

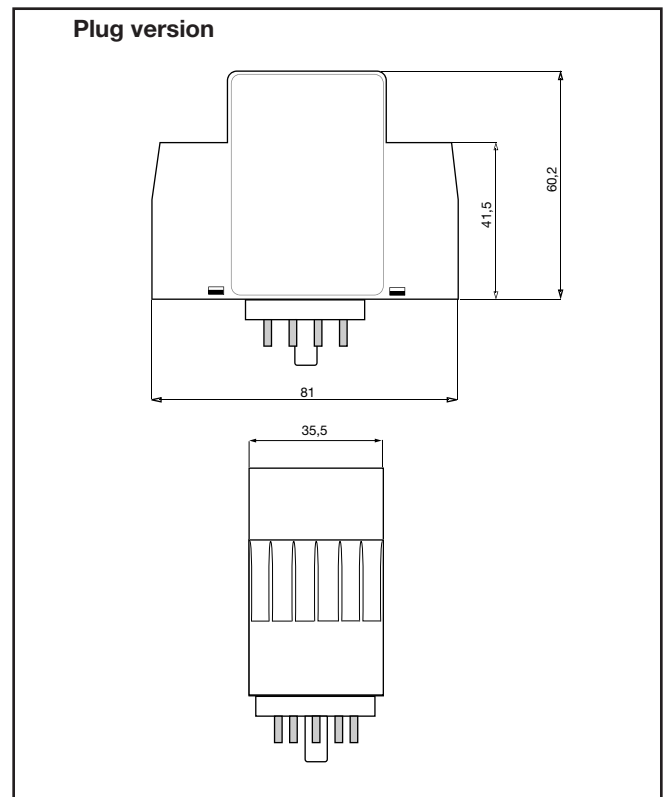
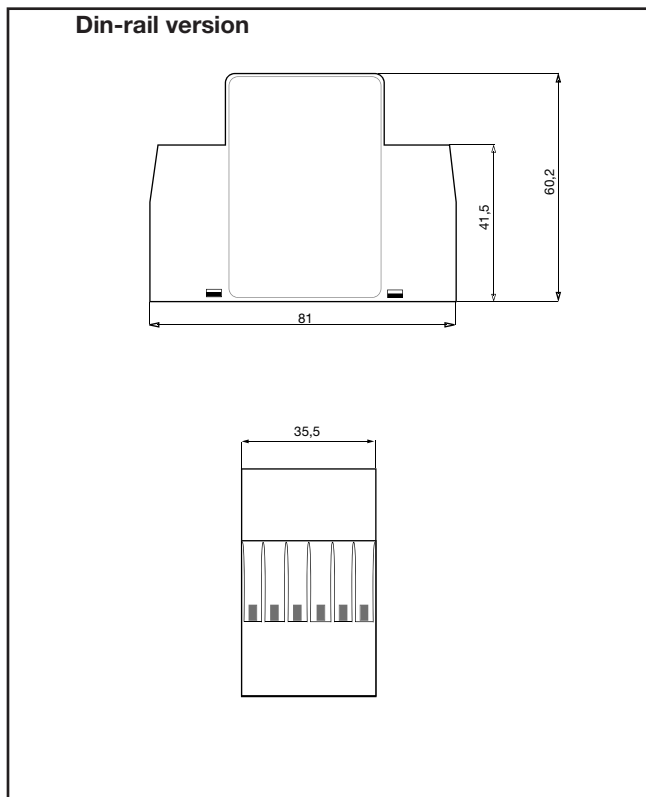

Accessories

- 11 pole circular socket ZPD11
- Retaining spring HF

Delivery Contents

- Amplifier
- Packaging: Carton box
- Manual